



Instruction Manual



STAT-CLEAN *Eye-02* STATIC SCALE



Thank you for purchasing our Static Scale No. Eye-02.

Read this instruction manual before use. Keep it in a safe handy place for future reference.

Table of Contents

■ For Your Safety	P.2
■ Product Features	P.3
■ Product Specifications	P.4
■ Preparation and Battery Replacement	P.6
■ Function Settings	P.6
■ Static charge voltage Measurement	P.7
■ Ion Balance Measurement	P.12
■ Table of Functions	P.18
■ Troubleshooting	P.19
■ Warranty	P.20

■For Your Safety

Safety Precautions

- Carefully read these Safety Precautions before use. Observe the precautions indicated herein to ensure safety.
- Safety precautions in this instruction manual are categorized into two types by the degree of danger associated with each of the followings.











 **WARNING** Indicates that improper handling can lead to serious injury or even death.

 **CAUTION** Indicates that improper handling can lead to minor injury and property damage.

 This symbol indicates a WARNING or CAUTION.

 This symbol indicates a prohibited action.

 This symbol indicates a mandatory required action

 CAUTION	
 PROHIBITED	Do not use the Eye-02 in environments that require explosion-proofing. The Eye-02 is not of explosion-proof construction, therefore explosion or fire may occur.
 PROHIBITED	Do not use the Eye-02 in environments subjected to sharp temperature fluctuations or dewing. This kind of environment can lead to breakdown.
 DO NOT WET	Do not use the Eye-02 in highly damp places or anywhere it may be wet by water, oil, solvent or other liquid. Contact with moisture can result in electric shock or breakdown.
 PROHIBITED	Do not press on the LCD display from the top.
 PROHIBITED	Do not apply any mechanical vibrations and shock.
 PROHIBITED	Do not insert any object in the opening for the sensor located at the measuring side of the instrument; no foreign substance should ever enter into the sensor opening.
 PROHIBITED	Do not open the case and modify the Eye-02. The performance (sensitivity, accuracy, etc.) may be impaired.
 PROHIBITED	Do not setup, use or service the Eye-02 until having understood the information in this instruction manual.
 REMEMBER	Keep this instruction manual in a safe handy place for future reference.

Features

Light weight and compact design

- This "lightweight & handy pocket sized" non-contact type static electricity measuring device is capable of measuring the Ion Balance of a static electricity removing device (ionizer) and measuring the Static charge voltage.
- Came with a soft case for easy to carry and store.

One-touch mode switching

- The Eye-02 contains a Multi functional microcomputer chip.
- Mode can be switched with four-coloured buttons for easy operation.

Easy-to-read the display

- Recognition properties of values has been improved with the adoption of a large LCD. And Checking the values in the dark has been easier with white LED lighting
- The numeric display can be hold temporarily by switching the HOLD mode. This is handy when using in places where the LCD display is difficult to see.
- The maximum value (peak value) can be displayed by switching to the MAX mode.

Beep sound

- Beep sound will be heard during Power-on, Power-off, Over-range, etc.

Cross mark indicated by red LED

- The Static charge voltage can be measured with ± 22 KV (22,000 V) at a distance of 25 mm.
- The cross mark (+) indicated with the red LED shows the proper distance for a clear view.

Ion Balance Measurement

- The Ion Balance voltage with ± 220 V can be measured by attaching the enclosed Ion Balance plate and switching to the Ion Balance mode. This mode is convenient for servicing a variety of static electricity removing devices (ionizer).
- A tripod, etc., can be screwed into the camera thread (female threads) on the back of the Eye-02 for increased stability during measurement.

Usage

Use the Eye-02 to investigate places of static electricity generation and charging levels, to select the static electricity removing device (ionizer) installation place and its effect, and for daily inspection of the static electricity removing device's performance.

■Product Specifications

Specifications

Model:	No.Eye-02
Display:	<ul style="list-style-type: none">● Large LCD display (digital and bar graph)● Mode selection at start-up: A value between 1 and 4 and a 4-step bar increment are displayed according to the time that the power button is held down.● Digital reading: three digits.● Bar graph: Positive polarity is displayed to the right, and the negative polarity to the left.● Selected function: MAX, HOLD, IB, A.ON or EL is displayed by pressing the button.● Battery level: The battery level is indicated with a battery mark.
Static charge voltage measuring:	<ul style="list-style-type: none">● Measurement range: 0 to ± 22.0 kV● Over range display: Value flashes, buzzer sounds (when + 22.0 kV is exceeded)● Digital reading: Lo range 0 to ± 1.50 kV (0.00 kV) Hi range ± 1.0 to ± 22.0 kV (00.0kV)● Bar graph display: LO range ± 0.1 kV per bar HI range + 1.5 kV per bar● Measuring distance: 25mm ± 0.5mm (between charged object and the Eye-02)
Ion Balance voltage measuring:	<ul style="list-style-type: none">● Measurement range: 0 to ± 220 V● Over range display: Value flashes, buzzer sounds (when + 220 V is exceeded)● Digital reading: 0 to ± 220 kV (000 V)● Bar graph display: ± 15 V per bar
Accuracy:	$\pm 10\%$ (LCD display renewal rate: 5 times/second)
Response time:	less than one second
Auto power off:	Power is turned off automatically after five minutes. Switch between on and off by pressing the power button.
Display lamp:	LED white lamp to assist reading in insufficient light Switch between on and off by pressing the power button.
ZERO Function:	The value and bar display can be reset to 0. Hold down the ZERO button during measurement.
HOLD Function:	The state can be changed between "temporarily hold the measurement (HOLD)" and "hold the maximum value during measurement (MAX)" with HOLD/MAX button.
Beep sound:	Beep sound will be heard during Power-on, Power-off, Over-range, etc.
Power source:	9V (006P), Maximum working time: Approx. 30 hours (using manganese batteries)
Ambient conditions:	0 to 50 °C, 0 to 80 %RH (no-condensing)
Overall size:	<ul style="list-style-type: none">● 123.1 (L)\times70 (W) \times25.3 (H)mm; without Ion Balance plate● 131 (L) \times73 (W) \times25.3 (H)mm; with Ion Balance plate
Weight with battery:	<ul style="list-style-type: none">● 170g; without Ion Balance plate● 200g; with Ion Balance plate
Materials	<ul style="list-style-type: none">● Case: Conductive resin (ABS)● Ion Balance Plate: SUS

Accessories

Ion Balance PLATE:	1
Ground Cord:	1 (With alligator clips)
Strap:	1
Battery:	1
Soft Case:	1

Overview and Name of parts

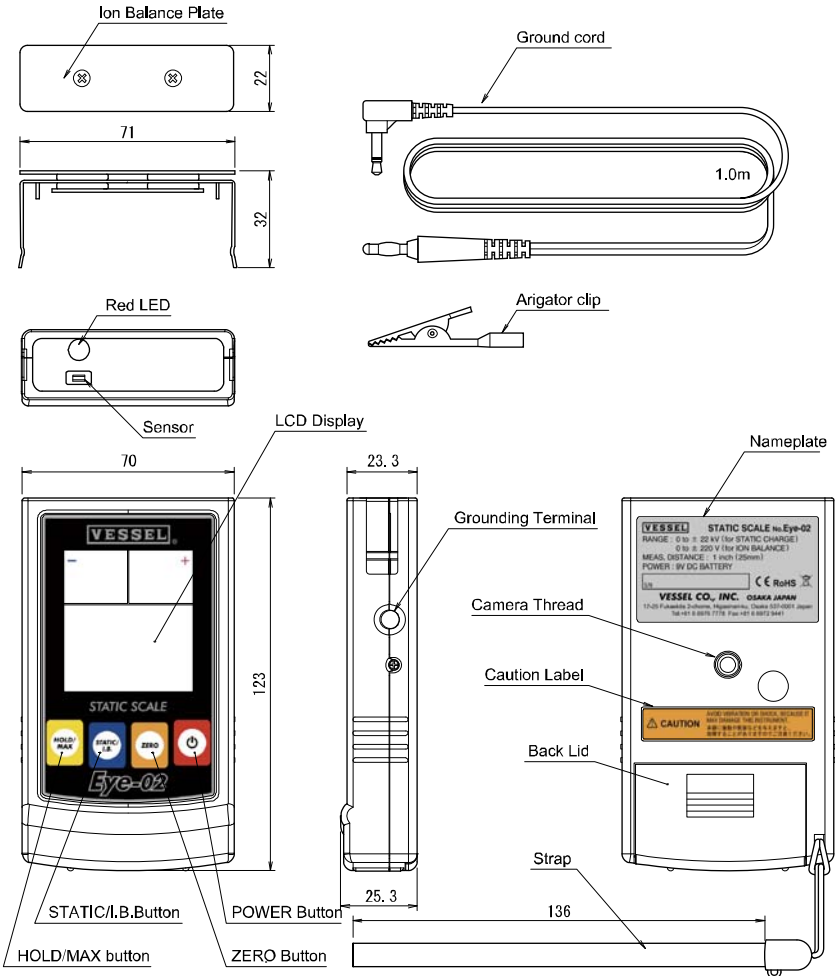

■Product Specifications

Names of LCD display parts

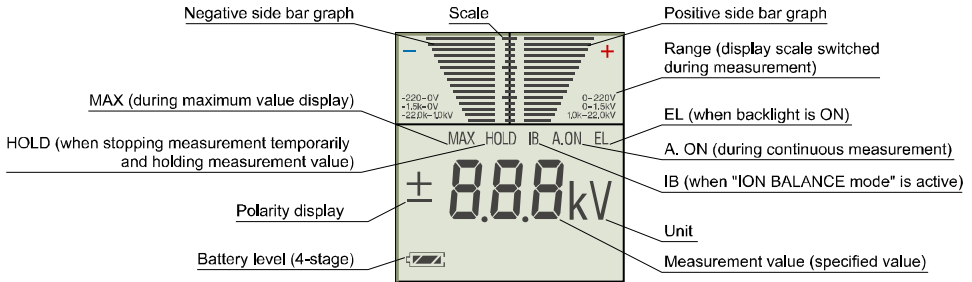

■Preparation and Battery Replacement

Attaching the strap

A strap can be attached to the static electricity measuring device Eye-02. Attach the enclosed strap to the Eye-02 before starting use. Damage to the device caused by dropping can be prevented by wearing the device on your wrist during measurements.

Installing the battery

This device runs with a 9 V (006P) battery. The battery is not installed at the time of shipment. Install the enclosed battery with the following procedure.

- 1) Press down on the indent on the back lid, and slide the lid open.
- 2) Connect the battery to the connection plug. Pay attention to the battery's polarity.
- 3) Set the battery into the battery compartment, and close the back lid.

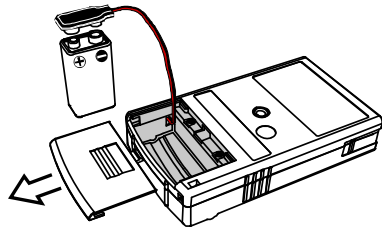

⚠ Installing the battery	
● REMEMBER	Do not exert excessive pressure; it might damage the lid.
● REMEMBER	The connection plug is delicate, so take care when attaching or removing a battery. Do not connect with force.
● REMEMBER	The plug will be damaged when it is connected forcibly in the wrong polarity terminals.
● REMEMBER	Remove the battery when not using the device for a long time to prevent damage caused by battery leaks.

■Preparation and Battery Replacement

Battery condition

The device can be used for approx. 30 continuous hours when using manganese batteries. The battery level is shown in the following manner. Refer to “Installing the battery” if the battery needs to be replaced. Note that the battery level display is not an equivalent amount. The level may drop suddenly depending on the condition of the battery and the working environment.

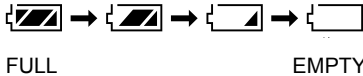



Battery level (4 stages)

Connecting the grounding cable

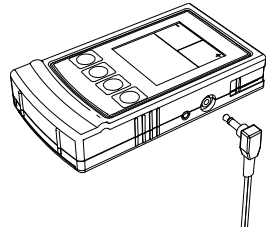
The accuracy might be affected by the static charge on the person making the measurement if Eye-02 is ungrounded. For proper measurement, the operator should be grounded using a wrist strap and/or Eye-02 shall be grounded on the right side grounding socket by the grounding lead provided with the equipment.



 Connecting the grounding cable	
 REMEMBER	The Eye-02 case is made of conductive resin. The grounding terminal functions as the reference for the measurement circuit. Always ground the terminal to ensure accurate measurements. The measurement accuracy will not be guaranteed if the terminal is not correctly grounded.



Handling the Ion Balance plate

This device is equipped with an Ion Balance plate for measuring the Ion Balance. The Ion Balance plate is mounted on the device's sensing section side when at the time of shipment.

Switch the measurement mode to measure the Ion Balance. Refer to “Selection of the measurement mode” for details on switching the measurement mode.

Remove the Ion Balance plate when measuring the Static charge voltage.

Before storing the device in the soft case, attach the Ion Balance plate onto the device's sensing section side to provide sufficient protection.

 Handling the Ion Balance plate	
 REMEMBER	Make certain that the surface of a white plastic plate under the Ion Balance plate is clean before attaching it to Eye-02 for Ion Balance measurement.
 REMEMBER	The Ion Balance plate should be stored or used in a place having less than 60 %RH.

■Function Settings

Selection of mode at start-up “auto power off” and “backlight”

The “auto power off” and “backlight” functions can be selected if the device is started up by holding down the power button.

The “auto power off” function should be turned off when performing continuous measurements.

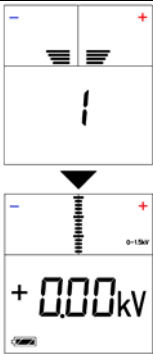
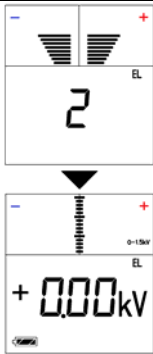
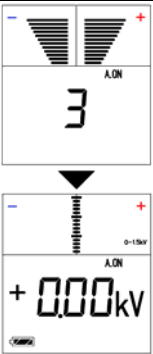
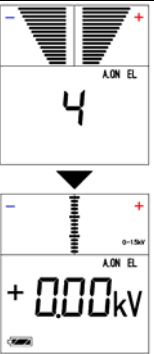
	Mode 1	Mode 2	Mode 3	Mode 4
Mode Display		EL	A.ON	A.ON EL
Auto power off	Power automatically turns off after approx. five minutes.		Power does not turn off until battery is spent.	
backlight	OFF	ON	OFF	ON
	Hold down power button for 1 to 2.5 seconds	Hold down power button for 2.5 to 3.5 seconds	Hold down power button for 3.5 to 4.5 seconds	Hold down power button for 4.5 to 5 seconds
LCD display				
Alarm	Beep	Beep	Beep, Beep, Beep	Beep, Beep, Beep

* The “auto power off” and “backlight” settings are valid in the “Static charge voltage measurement mode” and the “Ion Balance measurement mode”.

* If the power button is held down after “4” is displayed, “Mode 1” will reappear. The mode selection will repeat as long as the power button is held down.

* If the power button is pressed again in the power on state, the power turns off and all displays turn off. A single beep sounds when the power turns OFF.

* In the “continuous measurement mode” with the “auto power off function” stopped, the power does not turn off until the power button is pressed. When finished with the measurements, always press the power button and confirm that the displays and power have turned off.

* When the power is turned off, each mode setting and setting value is reset. These do not reappear when the power is turned on next.

Measurement mode selection

“Static charge voltage measurement” and “Ion Balance Measurement”

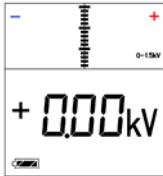
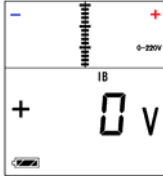

When the STATIC/I.B. button is pressed after starting up the device, the mode can be switched between “Static charge voltage measurement mode” and “Ion Balance measurement mode”.

	Static charge voltage measurement mode	Ion Balance voltage measurement mode
Mode Display		IB
	The “Static charge voltage measurement mode” is active when the power is turned on.	Press the STATIC/I.B. button after turning the power on. * Press again to return to the “Static charge voltage measurement mode”.
LCD display		
Alarm	No	No

* Attach the Ion Balance plate before measuring the Ion Balance. Refer to “Handling the Ion Balance plate” for information on attaching the plate.

Zero adjustment

If the ZERO button is held down after starting up the device, the measurement value and bar graph are cleared to zero.

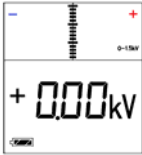
	Zero adjustment
Mode Display	-
	Hold down ZERO button.
LCD display	  
Alarm	Beep

* This functions only when the display value is within the tolerable range of digital zero operation.

(Static charge voltage: within ± 0.5 kV)
(Ion Balance: within ± 100 V)

* This does not function if the measurement value is fixed with the HOLD/MAX value.

* Note that if the ZERO button is inadvertently pressed during measurement, the digital zero adjustment will activate and the zero point will move.

■Function Settings

Retaining the measurement value “HOLD” and “MAX”

By pressing the HOLD/MAX button during a measurement, the state can be changed between “temporarily hold the measurement (HOLD)” and “hold the maximum value during measurement (MAX)”.

* When “temporarily hold the measurement (HOLD)” is selected, the measurement value at the point when the HOLD/MAX button is pressed appears. The red LED disappears, and the measurement stops. The measurement resumes when the button is pressed again. This is handy when using in places where the LCD display is difficult to see.

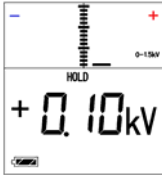
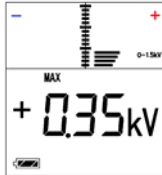

(During normal measurement, the display will fluctuate when the product is moved.)

* When “hold the maximum value during measurement (MAX)” is selected, the maximum value in the measurement always appears without stopping the measurement.

	Temporarily hold measurement	Hold maximum measurement value
Mode Display	HOLD	MAX
	Press HOLD/MAX button during measurement. * Press again to cancel.	Hold down the HOLD/MAX button during measurement. * Press again to cancel.
LCD display		
Red LED	Lamp turns off and measurement stops.	-
Alarm	-	-

* Even if the measurement value is fixed with the HOLD/MAX button, the value and settings are reset when the power is turned off. The displayed details do not reappear when the power is turned on next.

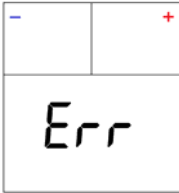
Other displays

	Sensor is faulty		Power was turned off
---	------------------	---	----------------------

■Static charge voltage Measurement

Standard Static charge voltage measurement mode

- 1) Face this device toward a charge-free space, and press the power button for 1 to 2.5 seconds. When the power turns on and “1” appears on the LCD display, release the button. A single “beep” sounds to indicate that the normal measurement mode has been entered.
- 2) The bar graph, scale, display range, polarity, measurement value, unit (kV) and battery level appear on the LCD screen. At the same time, the red LED for the cross mark on the front of the product turns on, and the measurement state is activated. Always check the battery level at this time. Refer to “Battery level display” for details on the battery level.
- 3) When the power button is pressed again in the power on state, a single “beep” sounds, the power turns off, and all displays turn off.
- 4) This product has an “auto power off function”. When enabled, the power turns off automatically about five minutes after the power is turned on. Four “beeps” sound to indicate that the power has turned off.

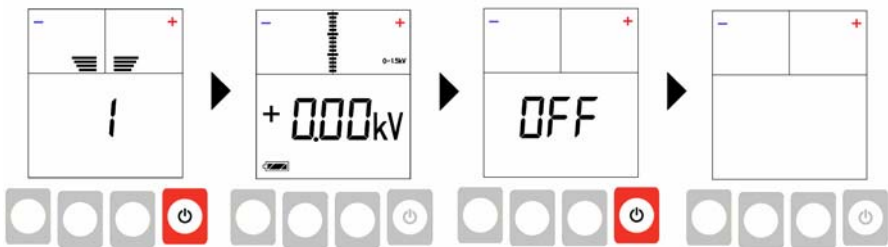

Standard Static charge voltage measurement mode

● REMEMBER

Eye-02 can be activated by pressing POWER button just once lightly. There is no need to press it repeatedly. Frequent unnecessary on/off operation or pressing by a nail may affect the life of switches and the cover sheet.

Always remove the Ion Balance plate when measuring the Static charge voltage.

- * Continuous measurement for longer than five minutes is not possible when the “auto power off function” is enabled. To measure continuously for more than five minutes, enable the following “Continuous mode for static charge voltage measurement”.

■ Static charge voltage Measurement

Continuous mode for static charge voltage measurement

- 1) Face this device toward a charge-free space, and press the power button for 3.5 to 4.5 seconds. When the power turns on and “3” appears on the LCD display, release the button. A “beeping” sound is made to indicate that the “auto power off function” has been canceled, and the “continuous measurement mode” has been entered.
- 2) The bar graph, scale, display range, polarity, measurement value, unit (kV), battery level and “A.ON” appear on the LCD screen. At the same time, the red LED for the cross mark on the front of the product turns on, and the measurement state is activated.
Always check the battery level at this time. Refer to “Battery level display” for details on the battery level.
- 3) When finished with measurement, turn the power button. A single beep sounds, the power turns off and all displays turn off.

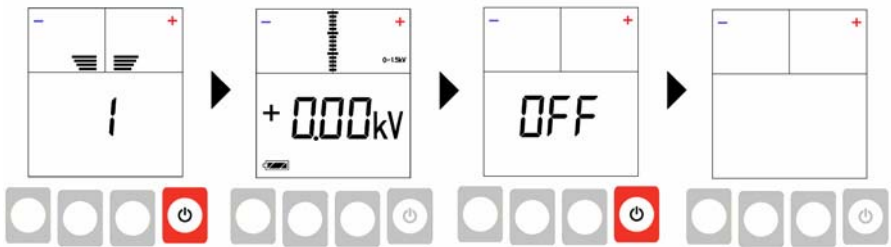

⚠ Continuous mode for static charge (voltage) measurement

● REMEMBER

Eye-02 cannot be turned off without pressing POWER button in continuous measurement mode. Confirm that power is turned off by observing the disappearance of all indicators. If power is not turned off, the battery will be drained completely.

* Eye-02 cannot return to this mode automatically, even if it is turned on again after turning off in continuous mode. For going into continuous mode, the operation described in “Continuous mode for static charge voltage measurement” is should be carried out when power is turned on.

■Static charge voltage Measurement

Measurement and cross mark

Move the sensing section on the front of the device gradually toward the charged object to be measured. This Eye-02 has an LED cross mark function which provides a guide of the distance from the charged object. Move the Eye-02 toward the charged object until the irradiated cross mark is clear.



Measurement distance

←Far (NG)



←O K



←Close (NG)

* The LED cross mark function is adjusted so that the cross pattern irradiated by the red LED light is clearest on a flat plate placed at a measurement distance of 25 mm. This can be confirmed by facing the Eye-02 toward a piece of white paper.



赤色LED

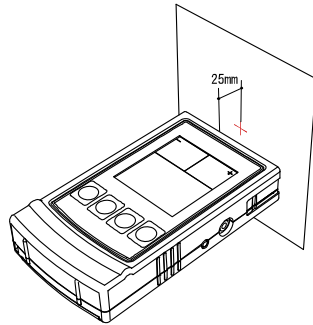

Measurement and cross mark



REMEMBER

If the digital numerical value blinks at [± 22.0] and a continuous “beeping” sound is heard while moving the measuring device, the charged voltage exceeds the measurement range (over range) of this measuring device, so stop the measurement. The internal sensor could be damaged if measurements are continued in this state.

■ Static charge voltage Measurement

Display

The bar graph and digital value displayed on the LCD display indicate the size of the static charge of the charged object being measured. This display has a LO range and HI range in which the position of the decimal point changes as shown below. This range changes automatically according to the size of the target object's charge.

LO range display

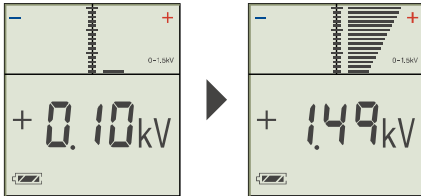

HI range display

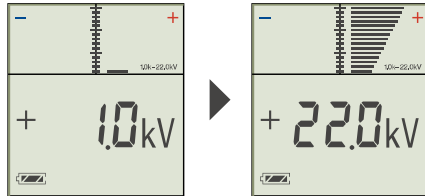

* The polarity of measured static charge is indicated by sign of [+] or [-] displayed to the left of the numerical value. In addition, the color of the bar graph indicates the polarity of the static charge, red being positive and blue negative.

Right: Positive charge Left: Negative charge

* Each bar of the bar graph corresponds to 0.1 kV (100 V) approximately for low range and 1.5 kV (1500 V) approximately for high range.

* Eye-02 is calibrated for the voltage range 0 to ± 20 kV, using a 150 mm x 150 mm charged flat metal plate placed at a distance of 25 mm. For any other distance, accuracy of measurement is not guaranteed. If a charged object is large enough and the measuring distance is correct, the display gives a direct reading of the Static charge voltage.

Display

REMEMBER

The accuracy is guaranteed only at a measurement distance of 25 mm. When measuring at a different distance, prepare calibration data and calibrate the measurement value and true value.

■ Ion Balance Measurement

A low voltage up to 220 V can be measured in the “Ion Balance measurement mode”. Align the Ion Balance plate to the notches on either side of the Eye-02’s sensing section, and properly mount the plate. This plate does not have a top/bottom orientation.

Grounding connection

Properly connect the enclosed grounding cord to the grounding terminal on the right side of the Eye-02.

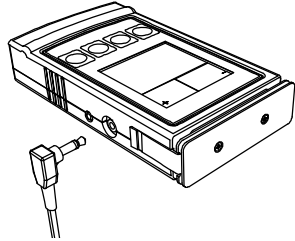

Grounding connection

● REMEMBER

The plastic case of Eye-02 is made of conductive resin. The grounding terminal provides the reference potential for the electrical circuit. This terminal should be grounded for proper measurement. The accuracy is not guaranteed for measurement with an ungrounded Eye-02.

Tripod attachment

A tripod can be attached to the camera threads (female threads) on the bottom of the case. (Tripod must be prepared separately.) The tripod helps to maintain an even height during the measurement, and is handy for measuring the Ion Balance of a blower type ionizer, etc.

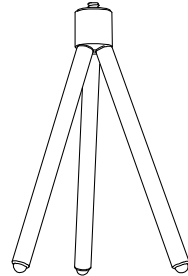
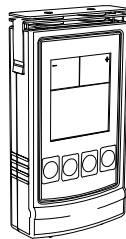
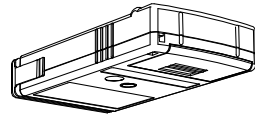

Measurement in the vertical direction

The Eye-02 can be stood on its end as shown below during measurements.

■ Ion Balance Measurement

Standard mode for Ion Balance Measurement

- 1) Hold down the power button for 1 to 2.5 seconds. When the power turns on and "1" appears on the LCD display, release the button. A single "beep" sounds to indicate that the normal measurement mode has been entered. The bar graph, scale, display range, polarity, measurement value, unit (kV), and battery level appear on the LCD screen, and the red LED for the cross mark turns ON.
- 2) Next, press the STATIC/I.B. button once. The IB mode appears, the range and unit (V) change, and the red LED for the cross mark disappears.
Always check the battery level at this time. Refer to "Battery level display" for details on the battery level.
- 3) Lightly touch the front of the Ion Balance plate with a finger to release the charge. (If wearing gloves, touch with a grounded wire, etc.) If a value other than 0 V appears on the LCD screen, press the ZERO button to adjust the zero point. (Refer to page 9.)
- 4) When the power button is pressed again in the power on state, a single "beep" sounds, the power turns off, and all displays turn off.
- 5) This product has an "auto power off function". When enabled, the power turns off automatically about five minutes after the power is turned on. Four "beeps" sound to indicate that the power has turned off.

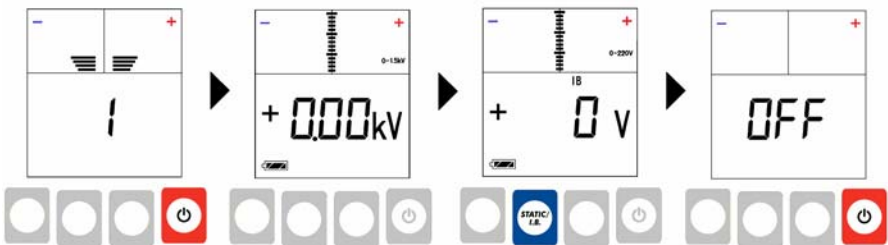

Standard mode for Ion Balance Measurement

REMEMBER

Eye-02 can be activated by pressing POWER button just once lightly. There is no need to press it repeatedly. Frequent unnecessary on/off operation or pressing by a nail may affect the life of switches and the cover sheet.

* In standard mode, the measurement cannot be done for more than five minutes when "Auto power off function" is operative. For more than five minutes measurement, select continuous measurement mode when power is turned on as described in the next section.

Continuous mode for Ion Balance measurement

- 1) Press the power button for 3.5 to 4.5 seconds. When the power turns on and “3” appears on the LCD display, release the button. A “beeping” sound is made to indicate that the “auto power off function” has been canceled, and the “continuous measurement mode” has been entered. The bar graph, scale, display range, polarity, measurement value, unit (kV), battery level and “A.ON” appear on the LCD screen. The red LED for the cross mark turns on.
- 2) Next, press the STATIC/I.B. button once. The IB mode appears, the range and unit (V) change, and the red LED for the cross mark disappears.
Always check the battery level at this time. Refer to “Battery level display” for details on the battery level.
- 3) Lightly touch the front of the Ion Balance plate with a finger to release the charge. (If wearing gloves, touch with a grounded wire, etc.) If a value other than 0 V appears on the LCD screen, press the ZERO button to adjust the zero point. (Refer to page 9.)
- 4) When the power button is pressed again in the power on state, a single “beep” sounds, the power turns off, and all displays turn off.

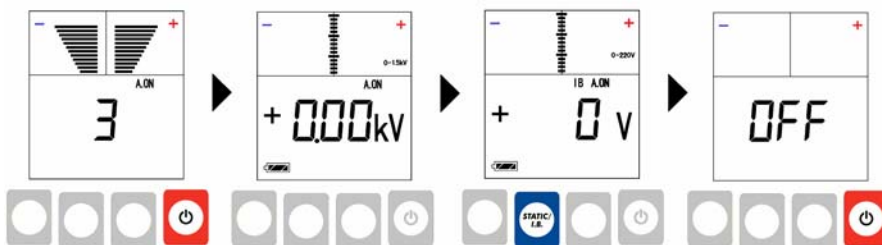

⚠ Continuous mode for Ion Balance measurement

● REMEMBER



Eye-02 cannot be turned off without pressing POWER button in continuous measurement mode. Confirm that power is turned off by observing the disappearance of all indicators. If power is not turned off, the battery will be drained completely.

* Eye-02 cannot return to this mode automatically, even if it is turned on again after turning off in continuous mode. For going into continuous Ion Balance measurement mode, the operation described in “Continuous mode for Ion Balance Measurement” should be carried out when power is turned on.







■ Ion Balance Measurement

Ion Balance Measurement

With the Ion Balance plate on Eye-02, approach an ionizer slowly from a distance. The numerical value and the bar graph, displayed on the LCD, indicate the Ion Balance voltage (offset voltage) due to the ionizer at that distance.

 Ion Balance Measurement	
 REMEMBER	If the digital numerical value blinks at $[\pm 220]$ and a continuous “beeping” sound is heard while moving the measuring device, the offset voltage exceeds the measurement range (over range) of this measuring instrument, so stop the measurement. The internal sensor could be damaged if measurements are continued in this state.

- * The + (plus sign) and - (minus sign) displayed to the left of the digital value indicates the polarity of the offset voltage. In other words, these indicate that the ionizer’s Ion Balance is deviated toward the indicated polarity. The polarity of the offset voltage can also be determined by the position of the displayed bar graph. Right side: positive voltage, Left side: negative voltage
- * Each bar of the bar graph corresponds to 15 V approximately.
- * Eye-02 goes into Ion Balance measurement mode when Ion Balance button is pressed, even if the Ion Balance plate is not attached or not attached properly. However, the measured value will not be correct.
- * Eye-02 is calibrated by applying DC voltage to the Ion Balance plate directly. If the plate is attached properly to EyeE-01, the display gives a direct reading of the Ion Balance voltage.

 Ion Balance Measurement	
 REMEMBER	Check periodically the insulation resistance of the Ion Balance plate assembly. For easy checking, confirm if the displayed value is decreasing after the plate is charged up to about 100 V. If the insulation resistance is low, the reading will decay quickly.
 REMEMBER	The insulation resistance between the Ion Balance plate and the stainless steel arms should be greater than $10\text{ T}\Omega$ ($10^{13}\Omega$)
 REMEMBER	To maintain the high insulation level of insulation of the Ion Balance plate, the Eye-02 should be stored in a place having less than 60 %RH. It should be kept inside a desiccator or in the soft case using desiccant.
 REMEMBER	In order to make more reliable measurement, we recommended that you create a data comparison and correction with CPM.
 REMEMBER	The Eye-02 should be recalibrated once a year. Please contact us or our agents when a recalibration of Eye-02 is necessary.

■TROUBLESHOOTING

Trouble	Cause	Countermeasure
The digital display and the bar graph on LCD do not change.	The Eye-02 is in hold mode.	Press HOLD button once again for canceling hold mode. Confirm that "HOLD" is not showed on the display.
Eye-02 gives a reading different from zero during zero checking.	The true zero point is shifted.	If the Eye-02 reads 50 V or more when power is turned on toward an uncharged object, readjustment is needed.
LCD shows nothing or a part is missing.	No battery or low battery	Put in a battery or replace the battery as required.
	Malfunction of the LCD	Repair or replacement is needed.
LCD backlight does not turn on.	The pressing time of POWER button is not correct.	Hold down the power button for 2.5 to 3.5 seconds when turning the power ON. (Refer to Selection of mode at start-up.)
Higher value is displayed even when measuring a grounded metal.	Eye-02 is turned toward a charged object with bad grounding or the operator is charged.	Turn toward an uncharged object. Ground Eye-02 using the grounding cord.
Display shows "Err".	Malfunction of the sensor.	Repair or replacement of the sensor is needed.
Beep sound does not activate.	Malfunction of the sensor.	Repair or replacement of the buzzer or PCB is needed.
Indicated voltage is high in Ion Balance mode.	It is not in Ion Balance mode.	Press Ion Balance button once. Confirm that "IB" is shown on the display and the unit changes to "V".
Indicated voltage is low in Ion Balance mode.	The insulation of the Ion Balance plate is dirty. Or it is in poor insulation by condensation.	Clean the plate by ultrasonic and dry completely in a desiccator or in a poly bag using desiccant.
		Repair or replacement is needed, if it does not recover after cleaning and drying.

* If the countermeasures fail or readjustment, repair or replacement is needed (except battery), do not use any more and please contact VESSEL with the product's serial number and information on the failure.

LIMITED WARRANTY:

Abbeon expressly warrants that for a period of one (1) year from the date of purchase, Abbeon static erasers will be free of defects in material (parts) and workmanship (labour). Within the warranty period, Defects occurring will be repaired or products will be replaced at Abbeon option and expense, if Abbeon receives notice during the warranty period. Defective products must be returned to Abbeon Osaka Japan with proof of purchase date. And if your unit is out of warranty, Abbeon will quote repair charges necessary to ship your unit freight prepaid to where you have originally purchased.

WARRANTY EXCLUSIONS:

THE FOREGOING EXPRESS WARRANTY IS MADE IN LIEU OF ALL OTHER PRODUCT WARRANTIES, EXPRESSED AND IMPLIED, INCLUDING FITNESS AND MERCHANTABILITY AND FITNESS FOR A PARTICULAR PURPOSE WHICH ARE SPECIFICALLY DISCLAIMED.

The express warranty will not apply to defects or damage due to accidents, neglect, misuse, alterations, operator error, or failure to properly maintain, clean, or repair products.

LIMIT OF LIABILITY:

This electronic static eraser use high voltage corona discharge and should not be used in or near flammable or explosive environments. In no event will Abbeon or any seller is responsible or liable for any injury, loss or damage, direct or consequential, whether based in tort or contract arising out of the use of or the inability to use the product. Fulfillment of Abbeon warranty obligations will be Customer's exclusive remedy and Abbeon and Seller's limit of liability for any breach of warranty or otherwise. Before using this unit, users shall determine the suitability of the product for their intended use, and users assume all risk and liability whatsoever in connection therewith.

Model	Eye-02	
Warranty	(1) year from the date of purchase	
Customer	Name	
	Address	
	Tel. No.	
Dealer	Name/Address/Tel. No.	



Abbeon Cal, Inc.
Industrial Plastic Working Equipment & Precision Instruments

Abbeon Cal, Inc.,

1363 Donlon Street Unit 1, Ventura, CA 93003-8387

800-922-0977 www.Abbeon.com E-mail: abbeoncal@abbeon.com